

Base/Sokkel for F 371/F 377/F 378

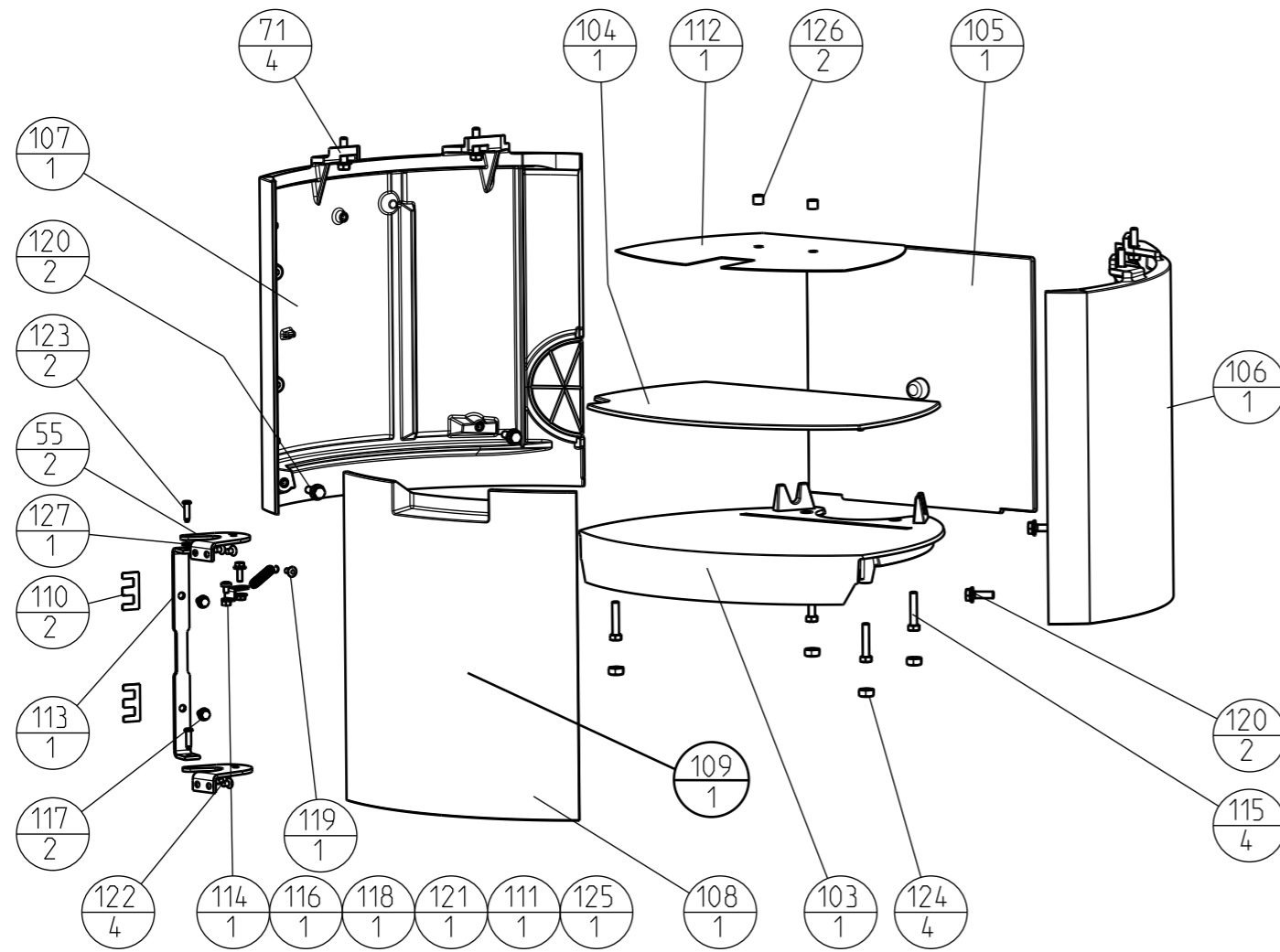

Pedestal/søyle for F 373

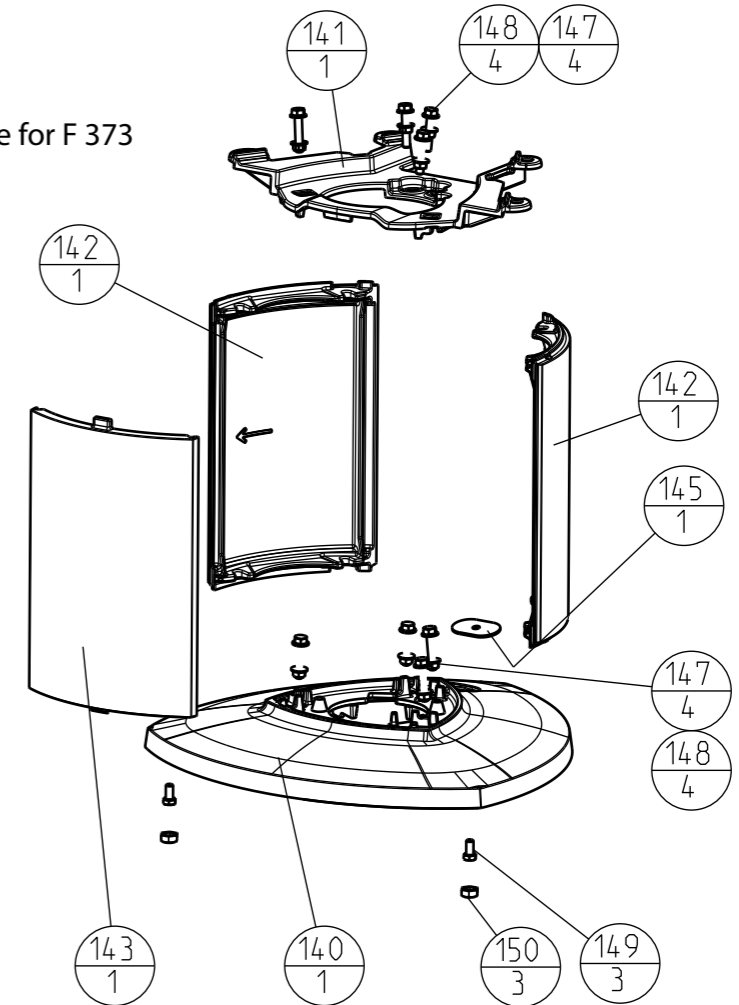

Rotation kit/Dreiesett for F 373

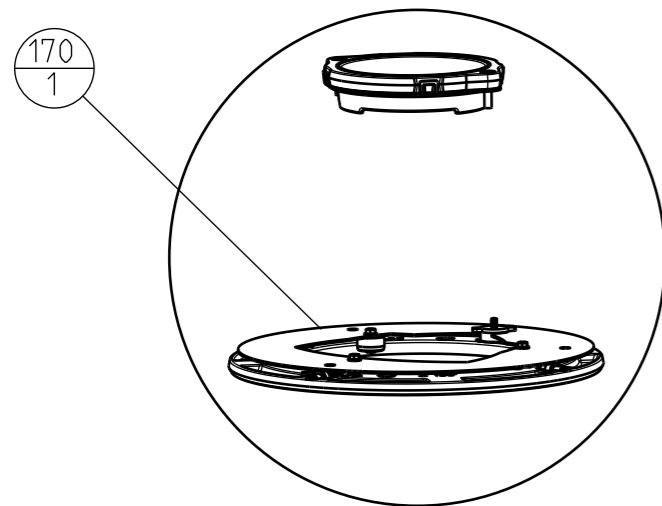

High top for F 371/ F 377/ F 378

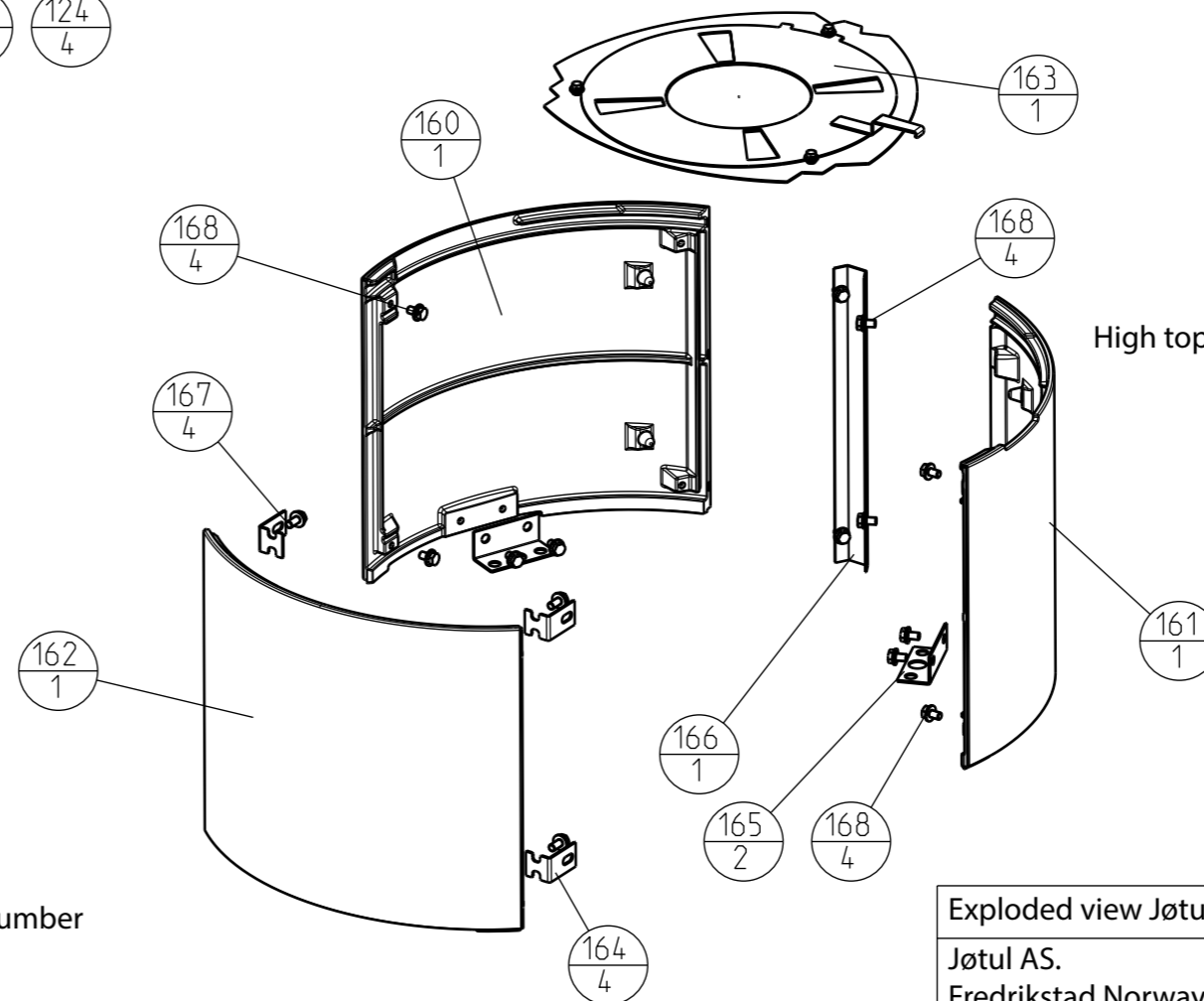

XX - Position number
YY - Quantity

Exploded view Jøtul F 360v2/F 370v2 Advance

Jøtul AS.
Fredrikstad Norway

Draw no:900357-P03
Page 2 of 4

Date: 22.02.23

Soapstone/Kleber F 370 Advance high top

Soapstone/Kleber F 370 Advance

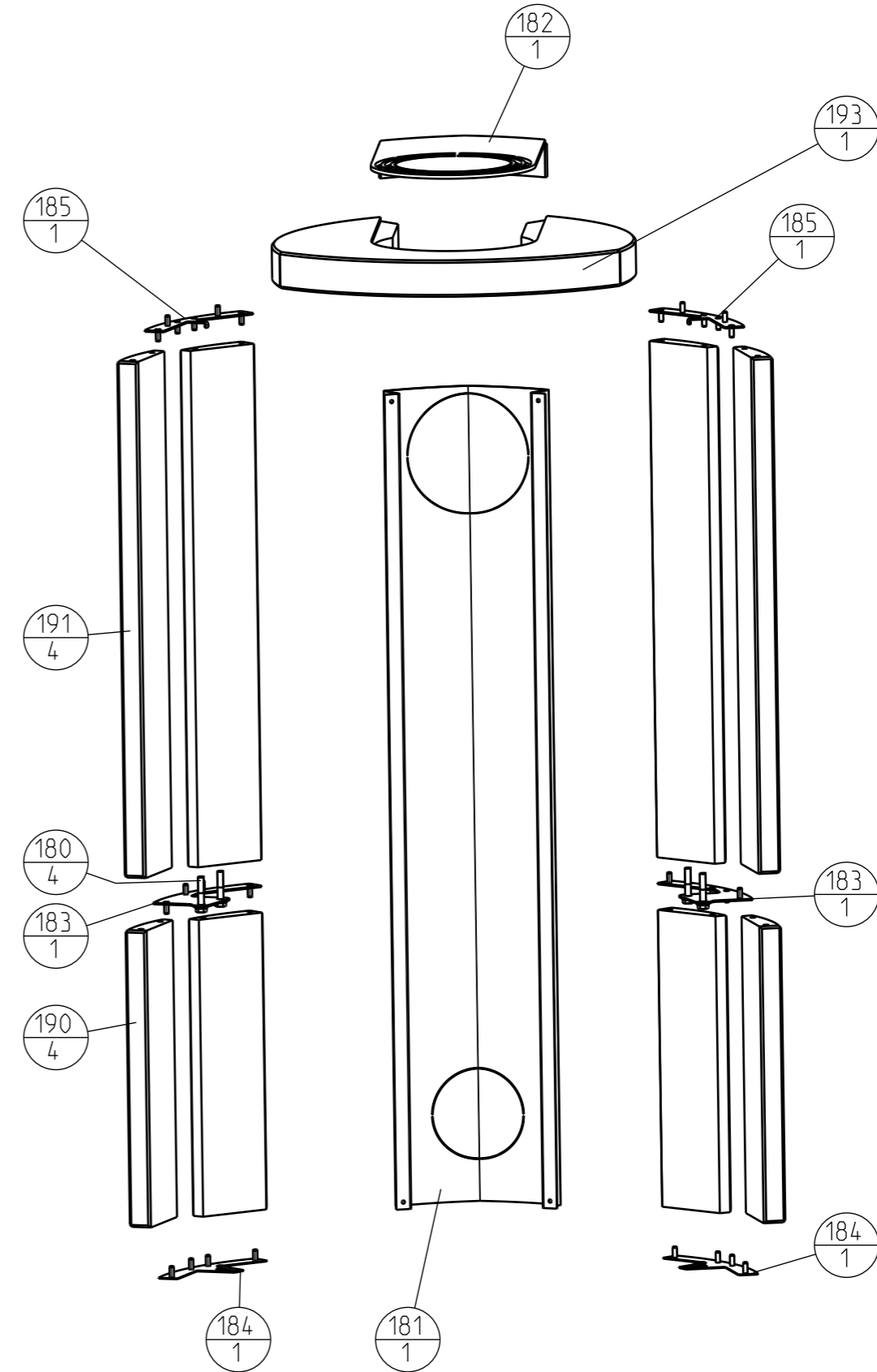
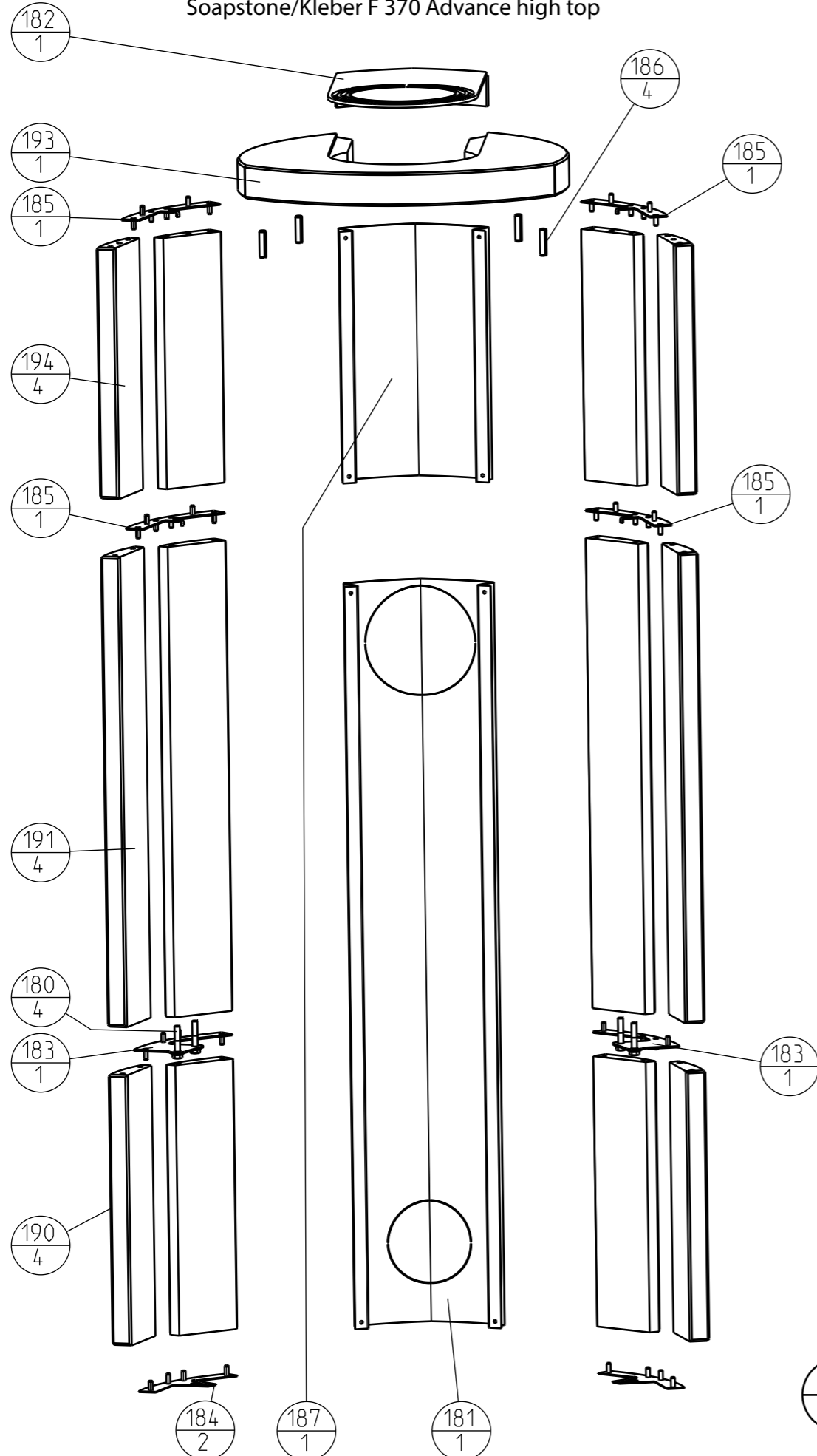

XX XX - Position number
YY YY - Quantity

Exploded view Jøtul F 360v2/F 370v2 Advance

Jøtul AS.
Fredrikstad Norway

Draw no:900357-P03
Page 3 of 4

Date: 22.02.23

Optinal equipment/Tilleggsutstyr

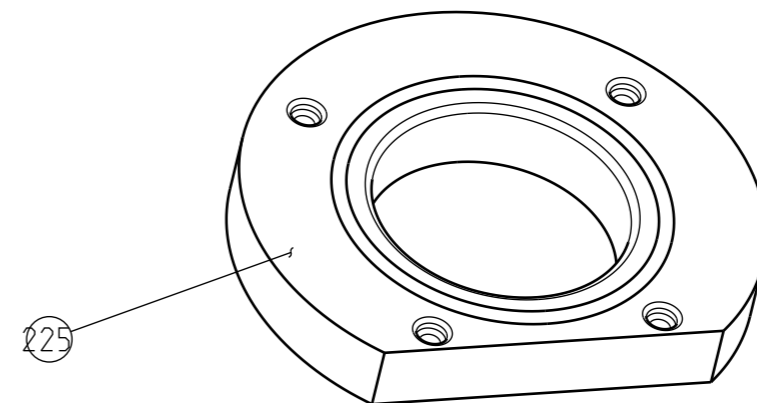
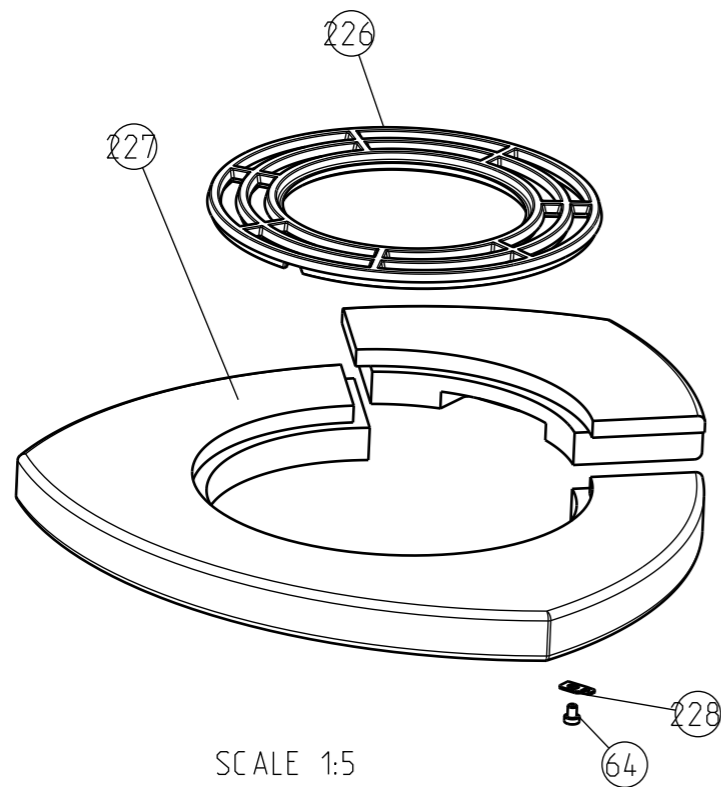
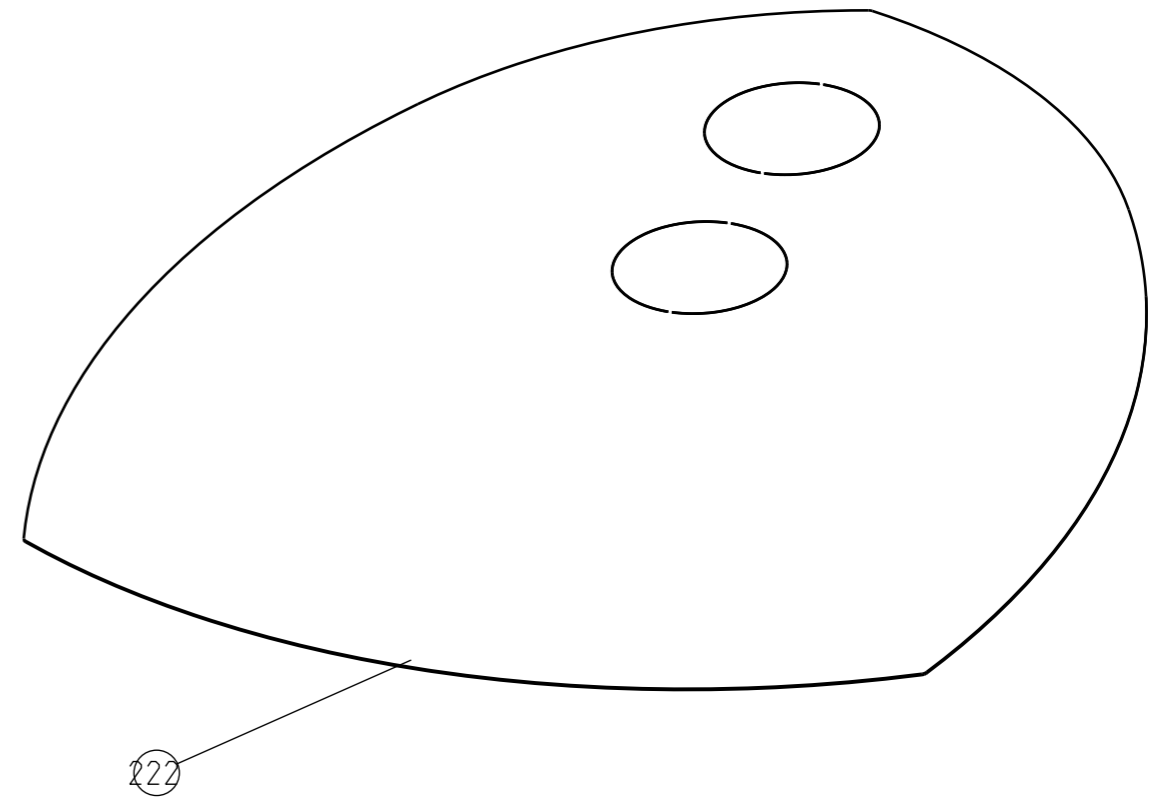
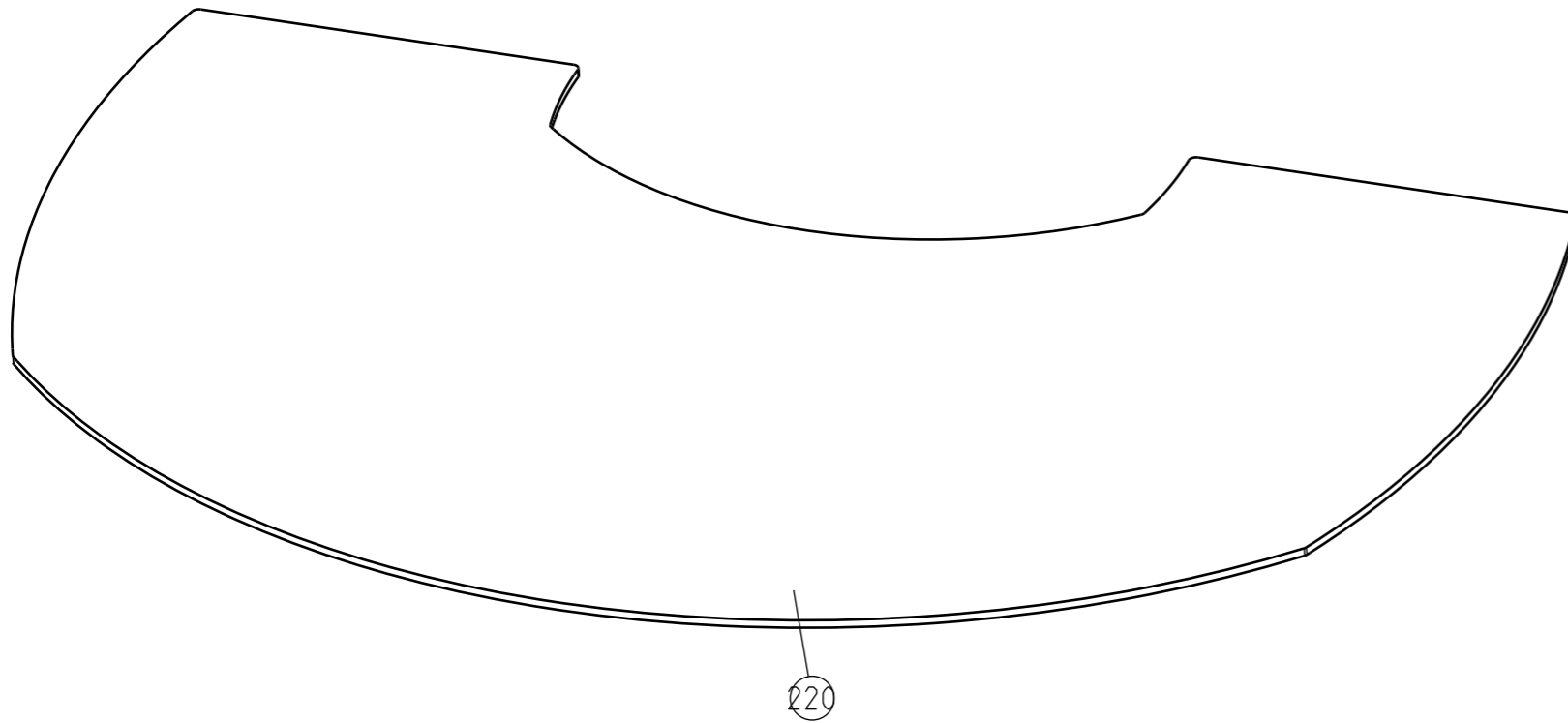

SCALE 1:5

Exploded view Jøtul F 360v2/F 370v2 Advance		
Jøtul AS. Fredrikstad Norway	Draw no:900357-P03 Page 4 of 4	Date: 22.02.23